

轉接頭

CP

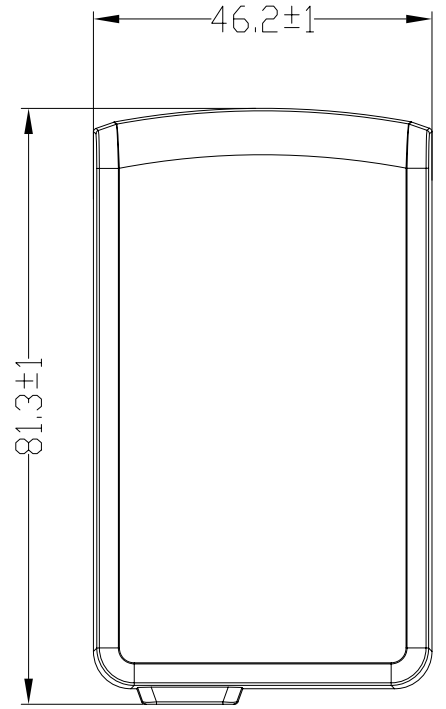

UL

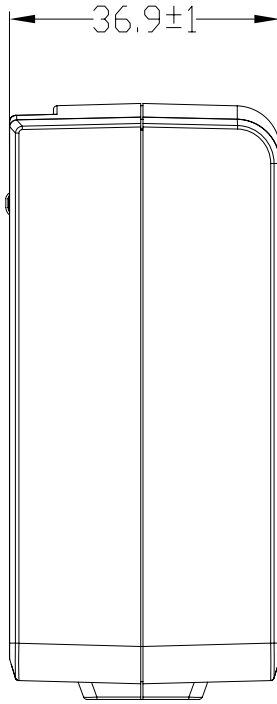
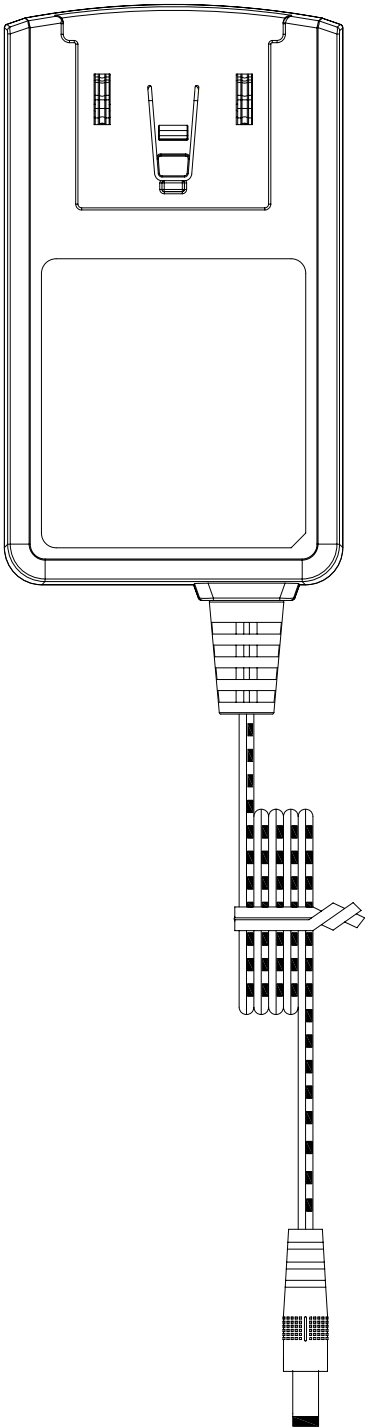
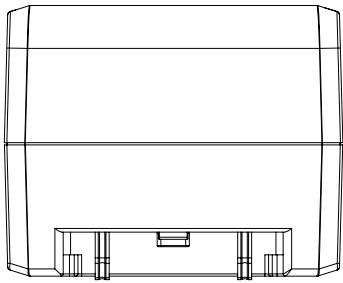
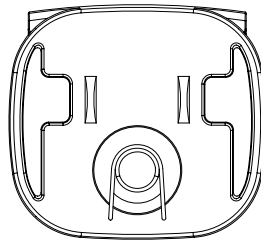

GS

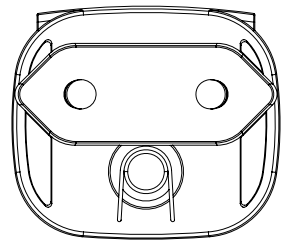

SAA

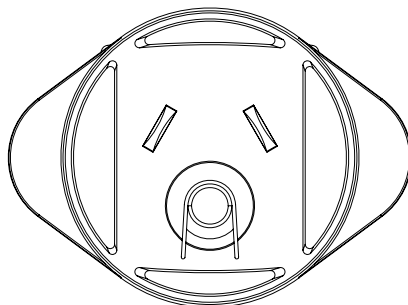

BS

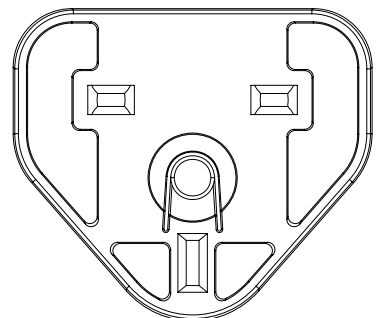

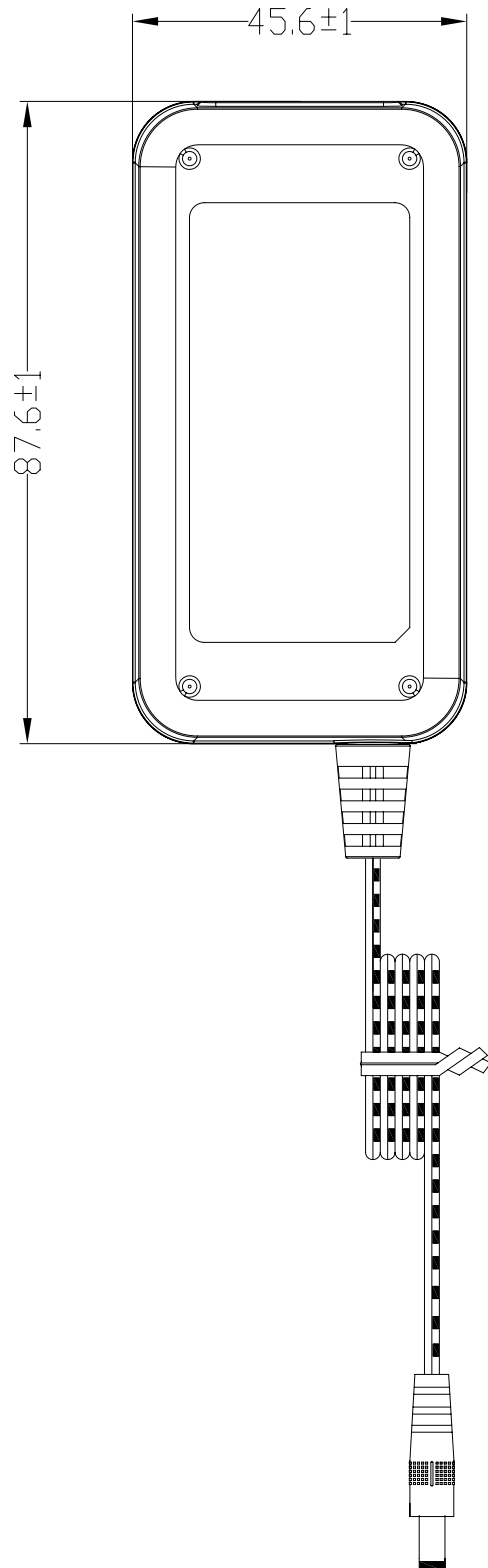
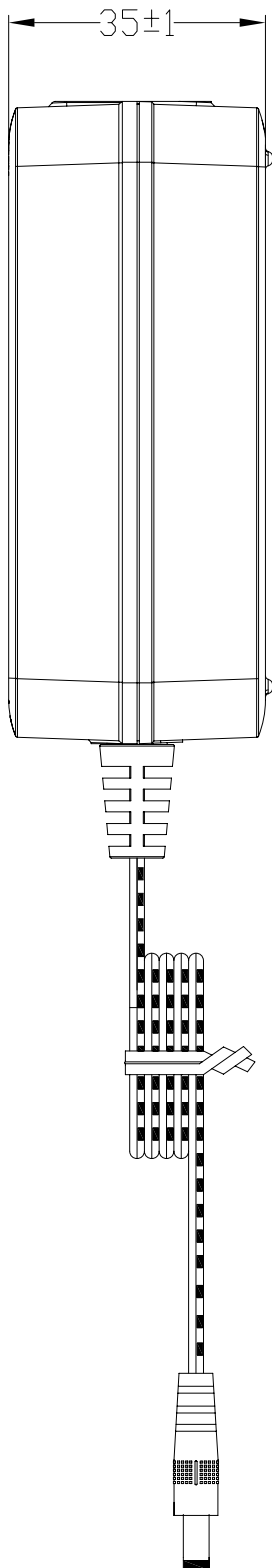
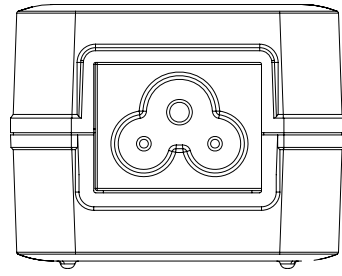

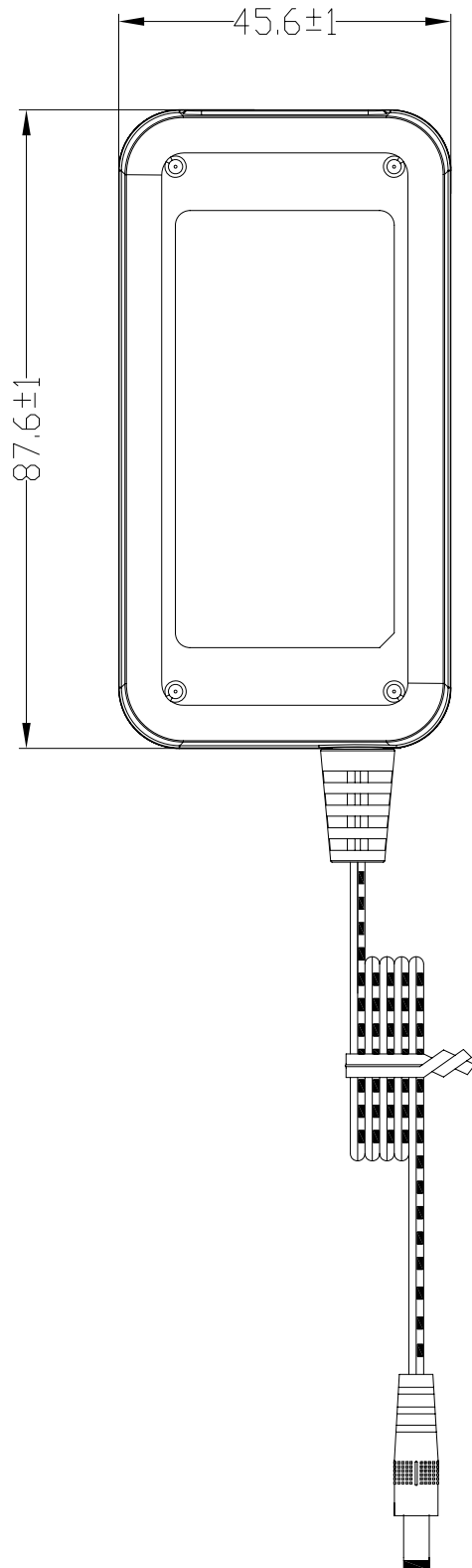
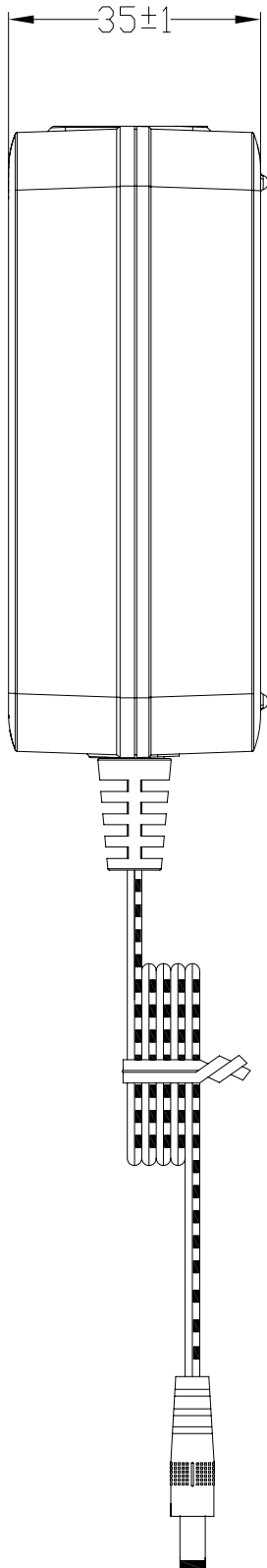
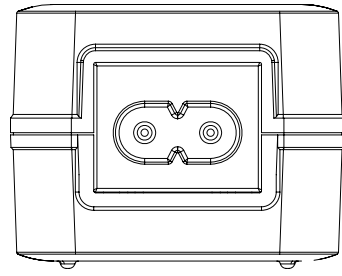

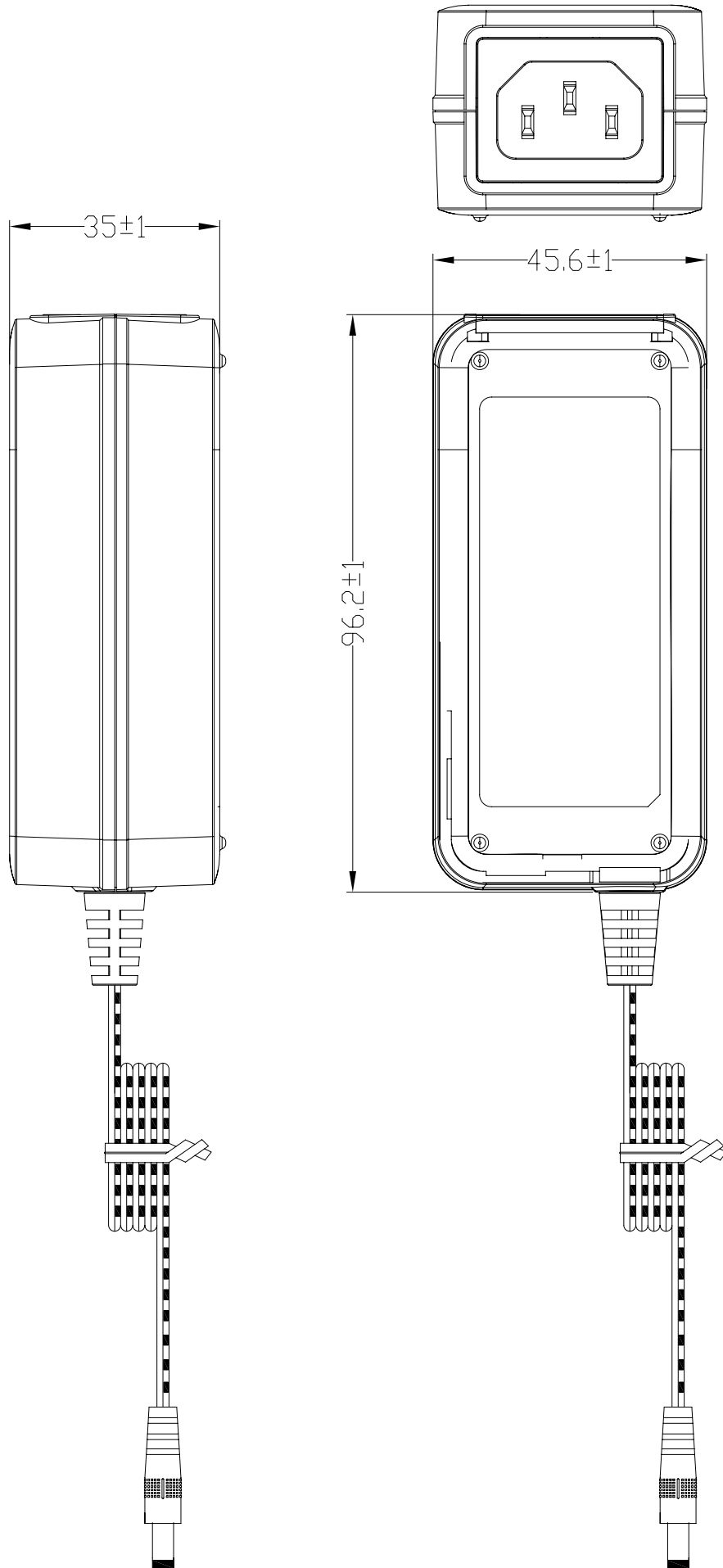

ACPLUG

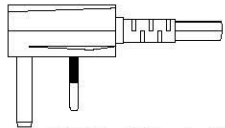

**UK CLASS II
OR CLASS I**

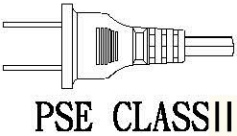

PSE CLASS II

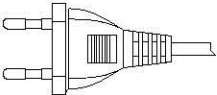

KOREAN CLASS II

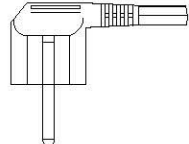

TUV CLASS I

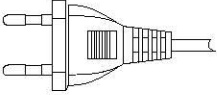

TUV CLASS II

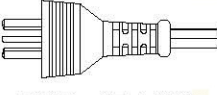

CCC CLASS I

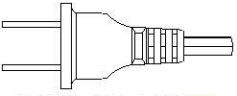

CCC CLASS II

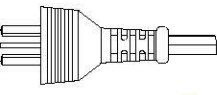

SAA CLASS I

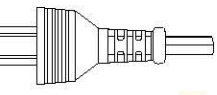

SAA CLASS II

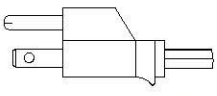

UL CLASS I

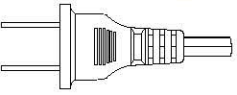

UL CLASS II

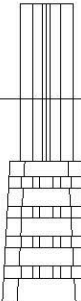
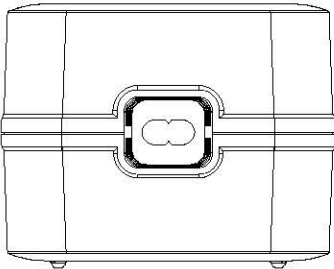

45.6 ± 1

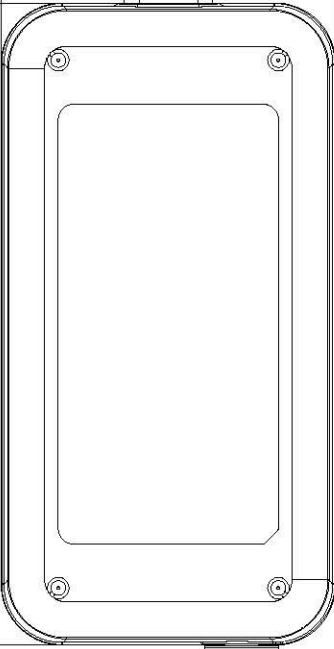

87.6 ± 1.0

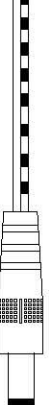
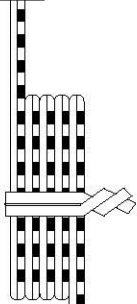
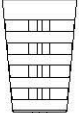

35 ± 1

